

to do:

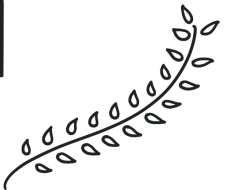

Σ H2O

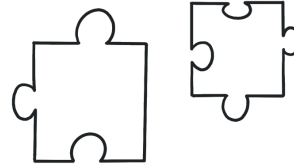

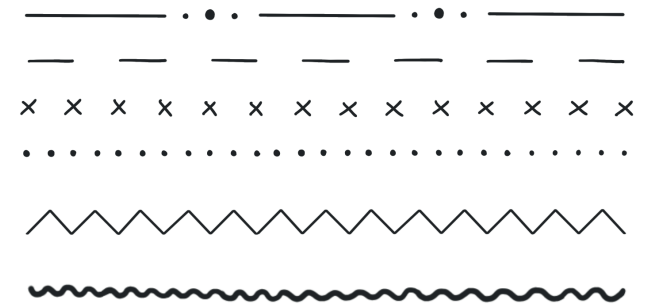
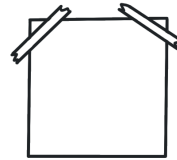
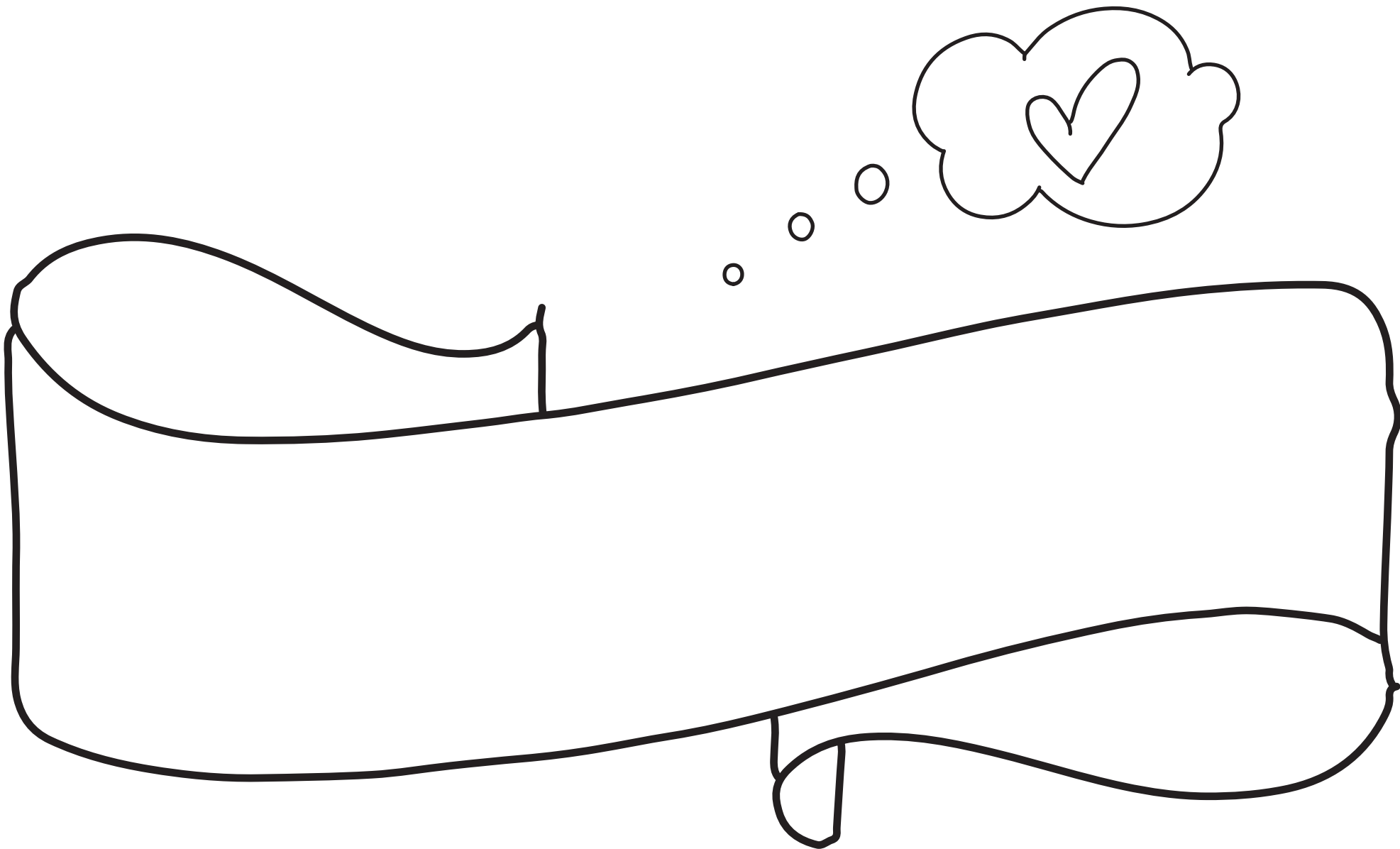

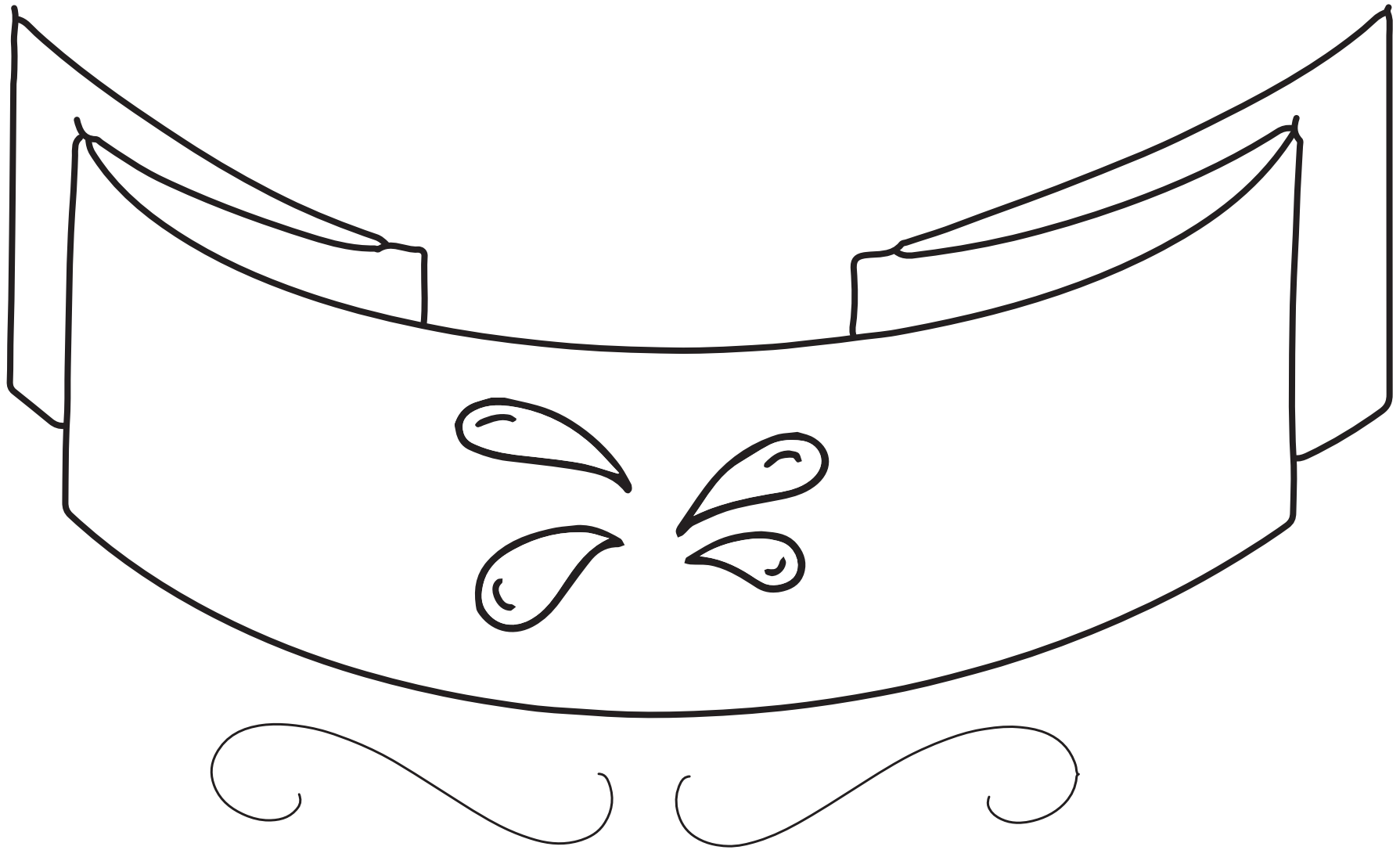

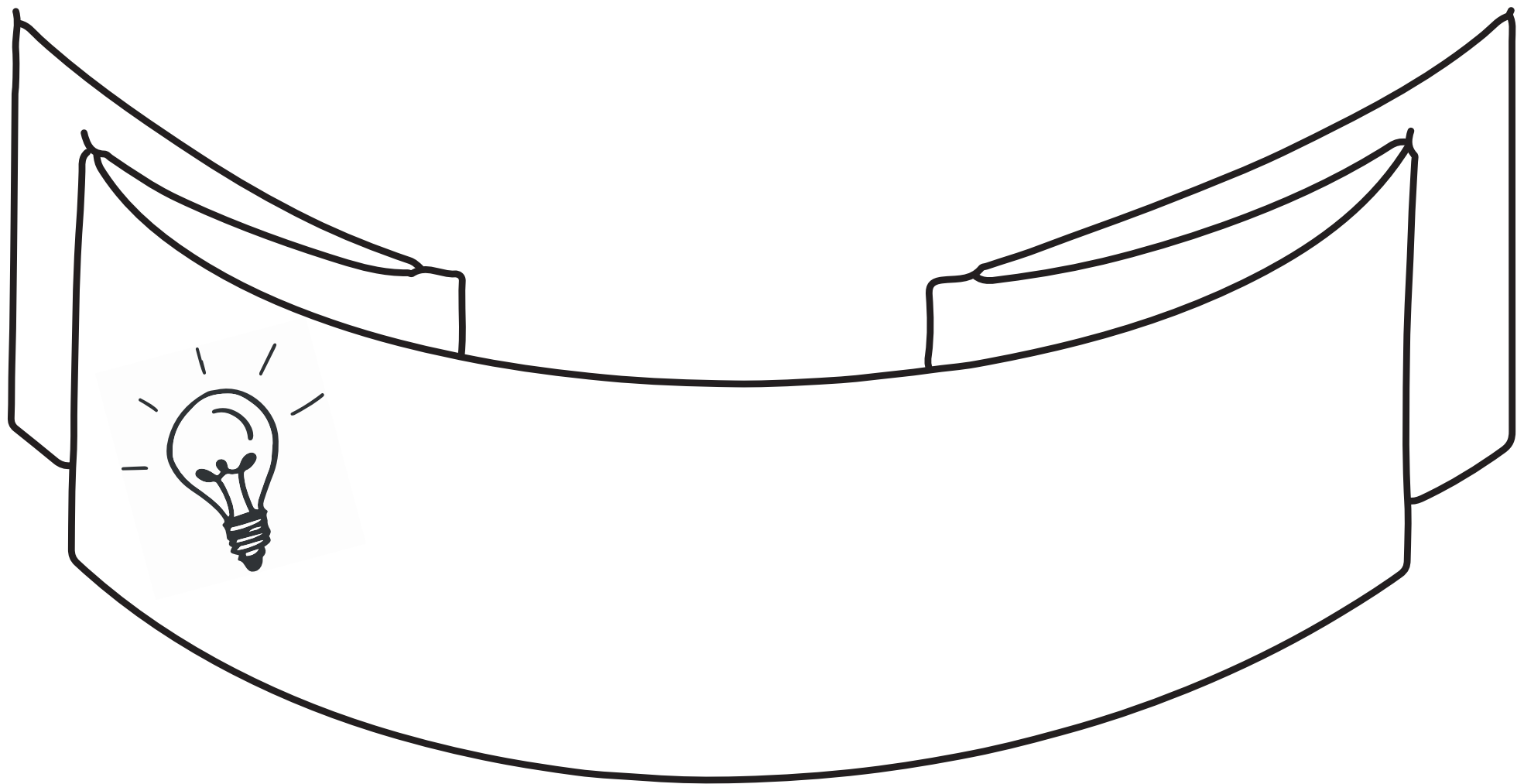

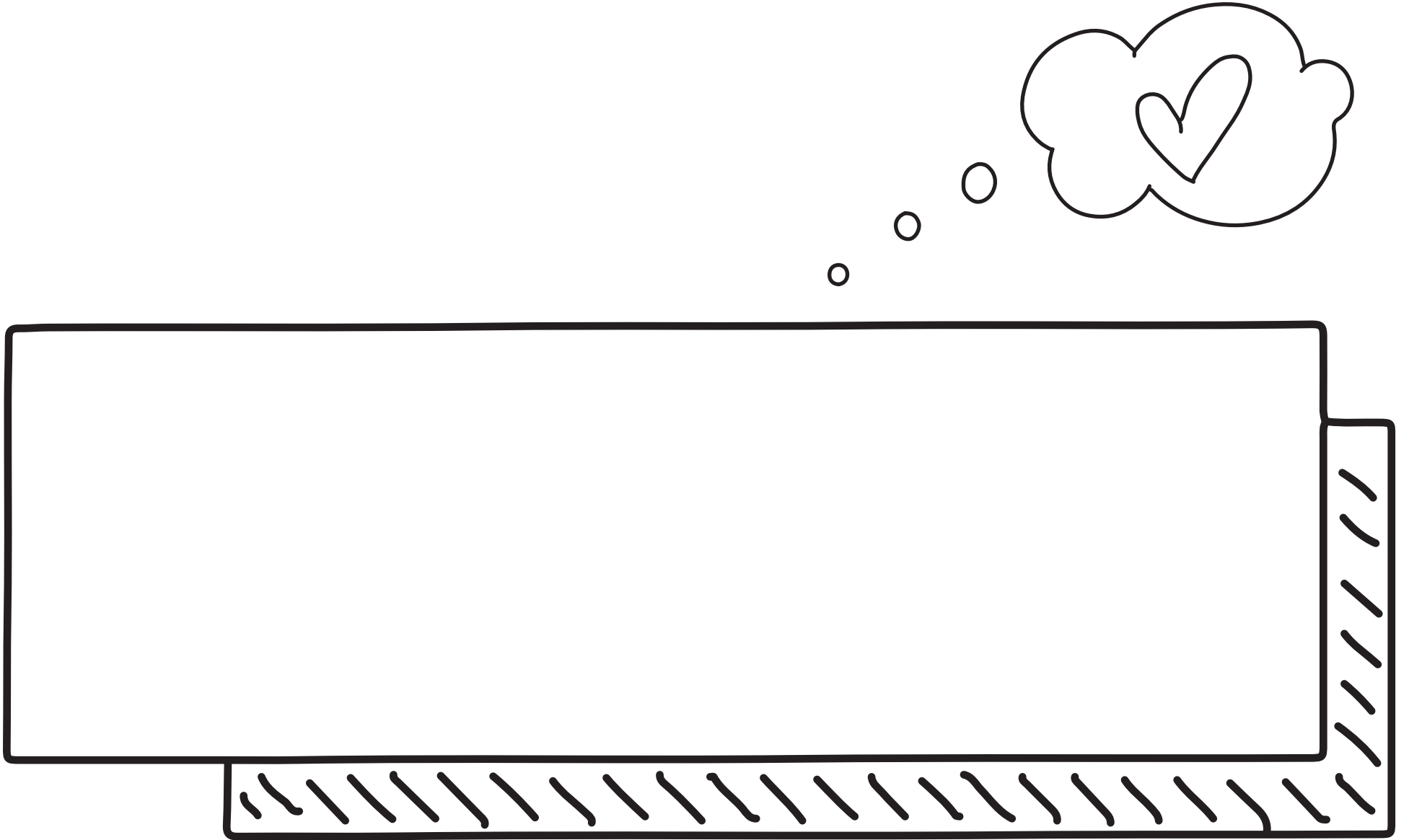

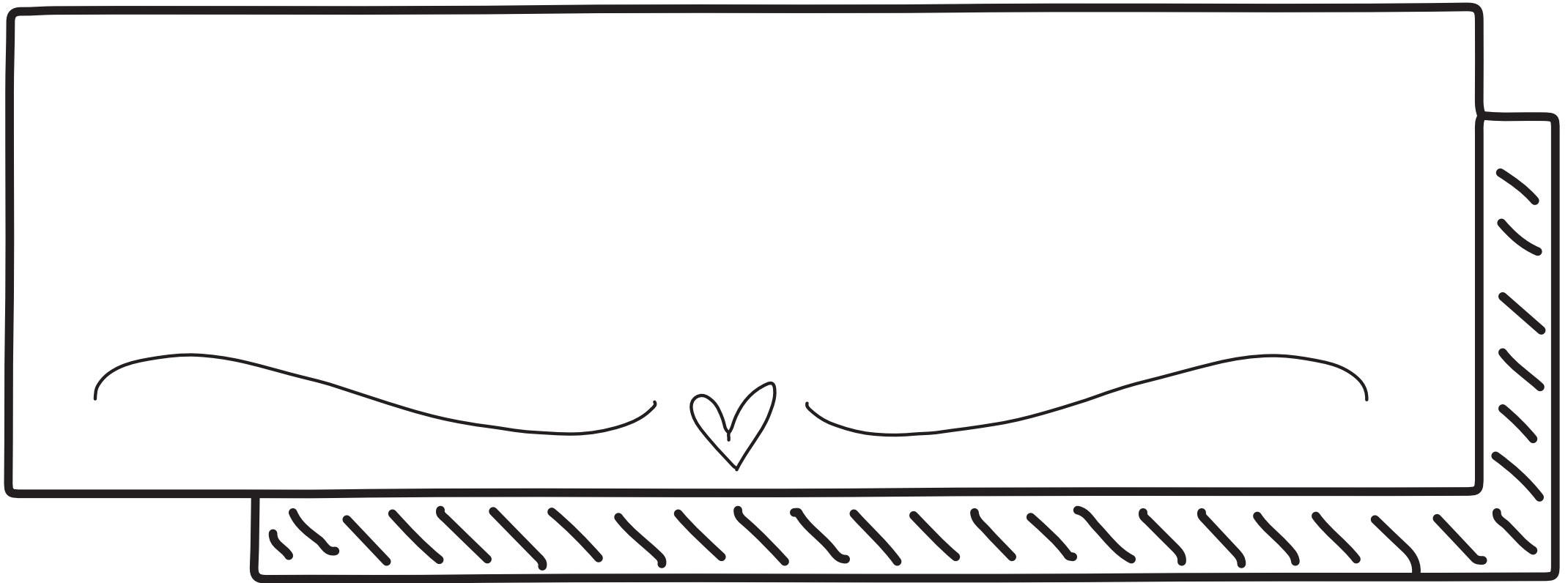

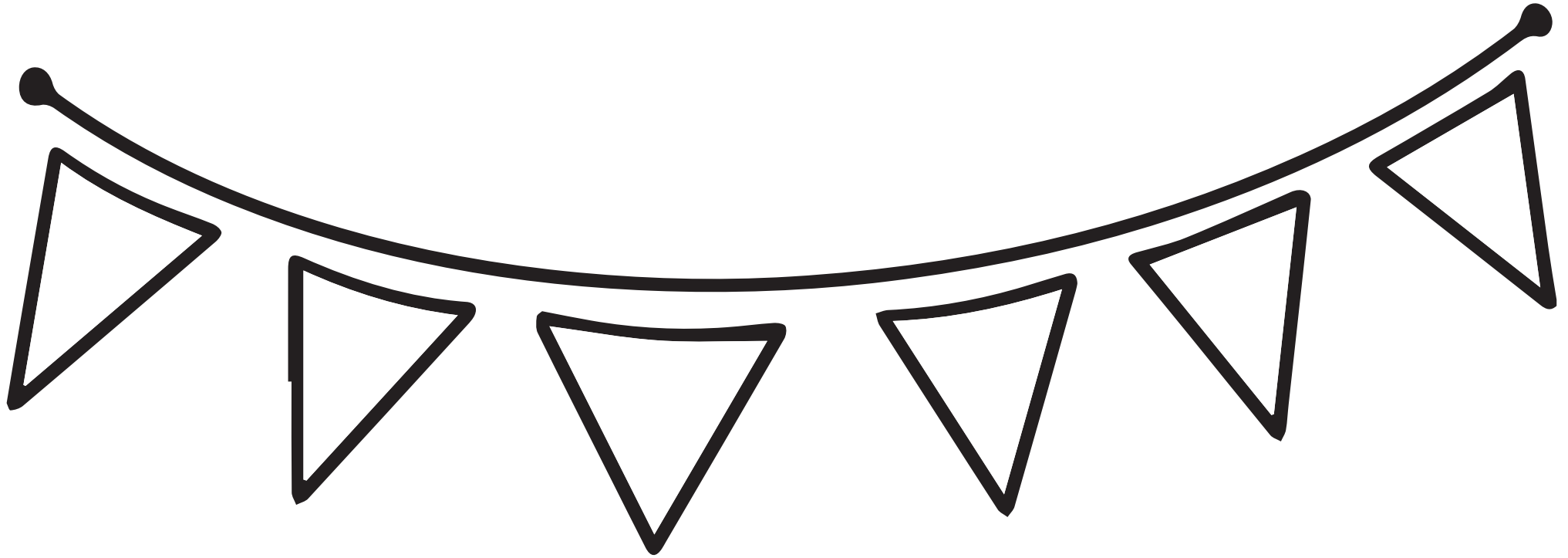
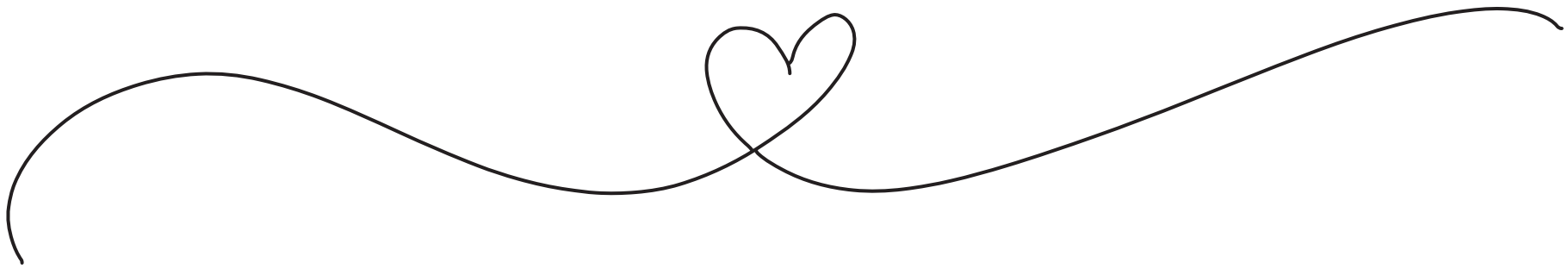

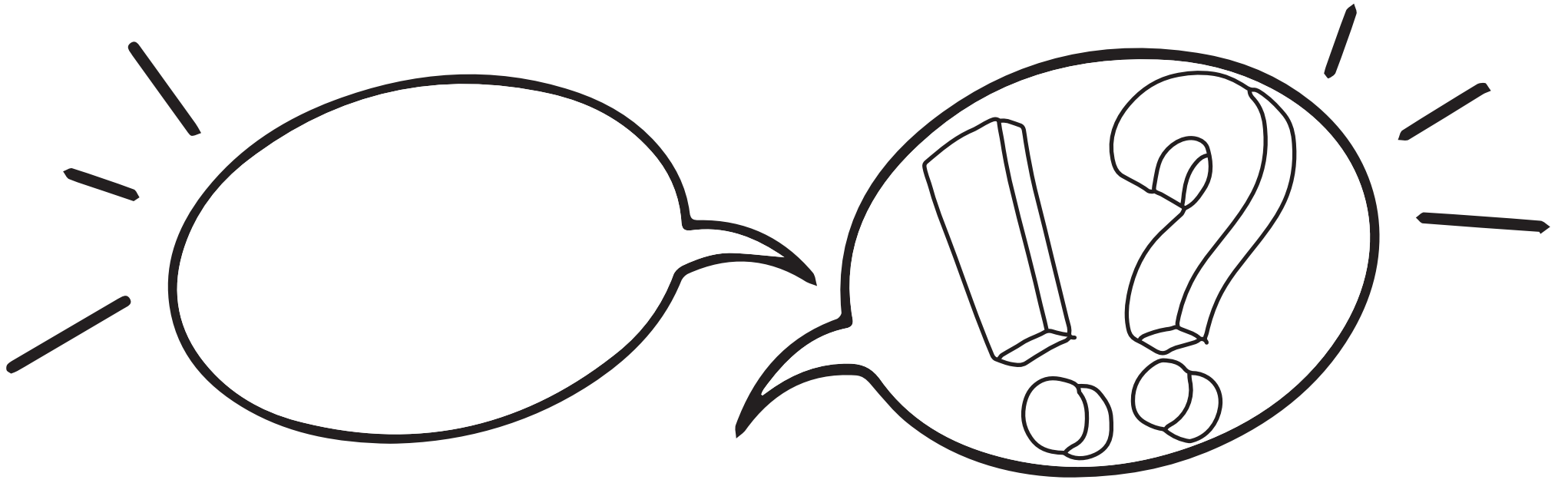

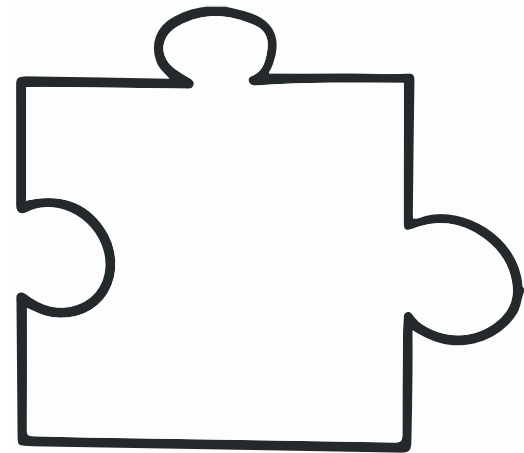
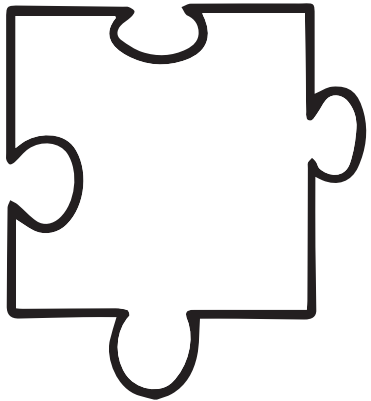
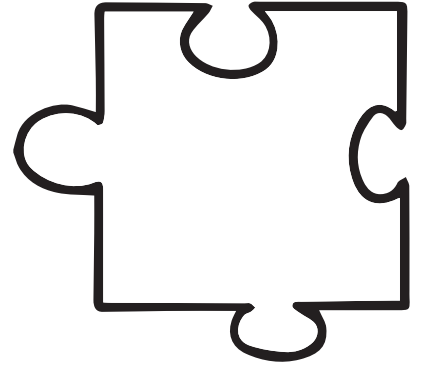
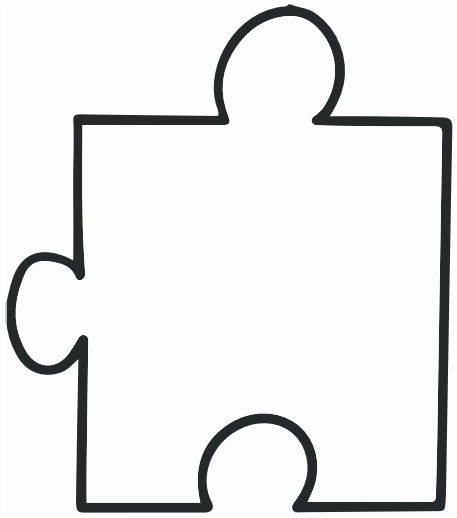

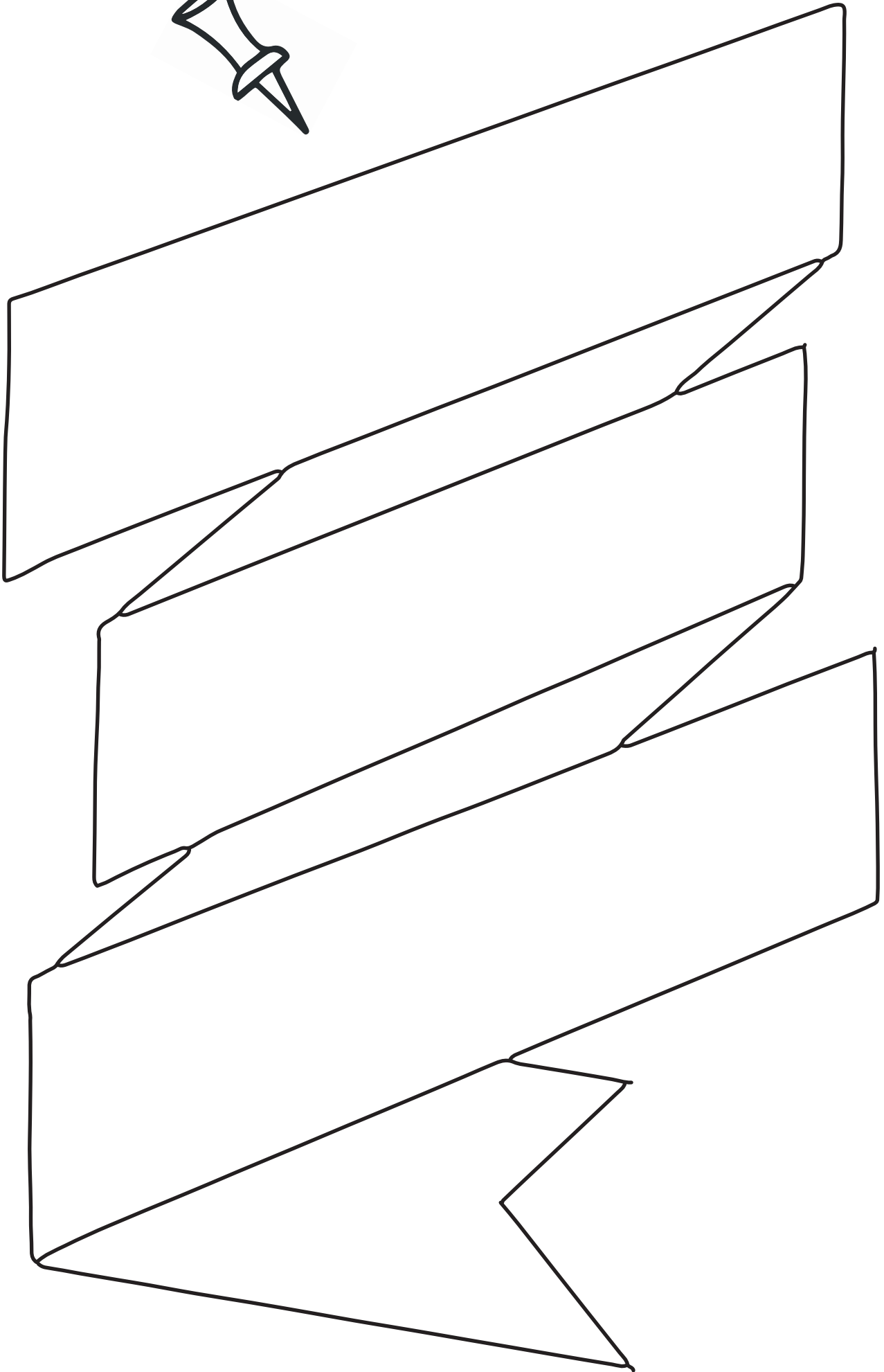
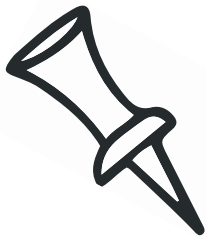

TO DO:

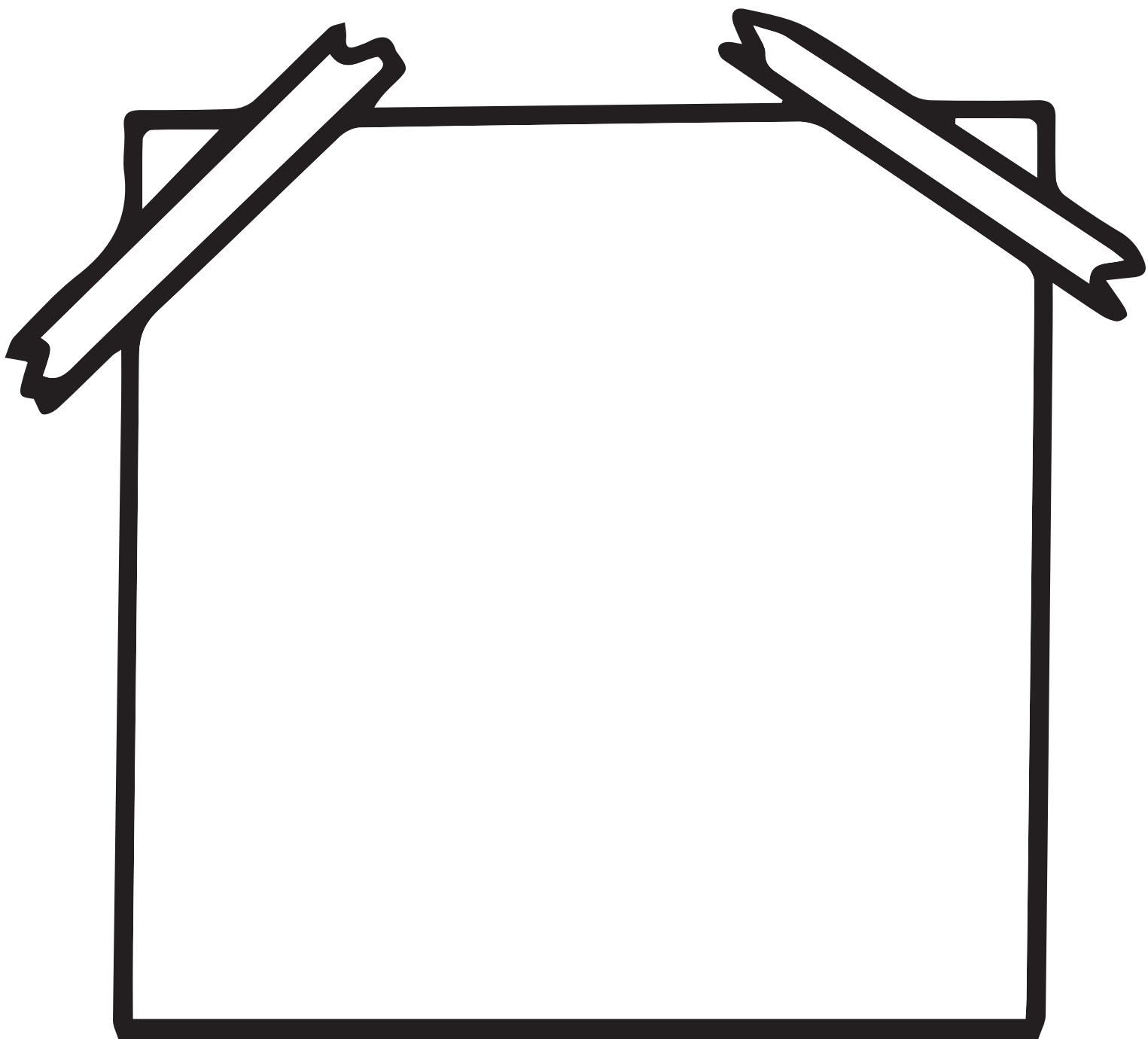

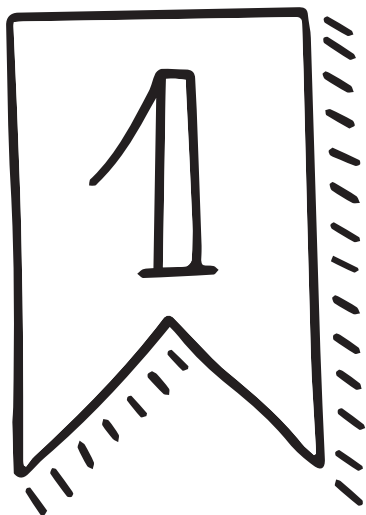

to do: